

2020

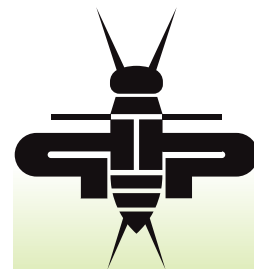

Grillo

AGRIGARDEN
MACHINES



G Z1 - G Z2







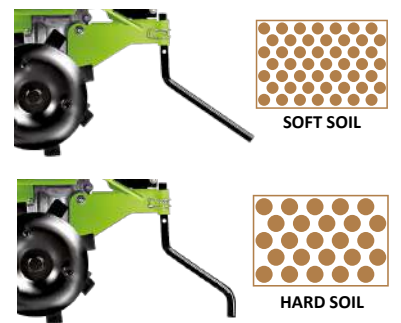
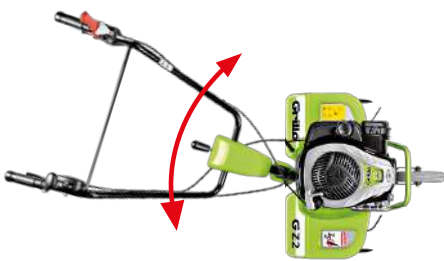

G Z1



G Z2



										
G Z1	575 EX B&S	HP 3 - kW 2.2	140/1	0,8 (0.84)		GEAR TRANSMISSION 155 rpm	--	A 28 cm (11 in)	52 cm (20 in)	35 (77)
G Z2	575 EX B&S	HP 3 - kW 2.2	140/1	0,8 (0.84)		GEAR TRANSMISSION 155 rpm	Max 2,1 km/h (1.3 mph)	A 28 cm (11 in)	52 cm (20 in)	41 (90)

G Z3

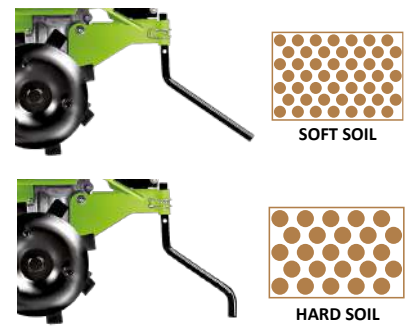

		HP-kW	CC	DIESEL L (US qts)						
G Z3	GCV 160 Honda	HP 4.4 - kW 3.3	160/1	0,9 (0.95)		GEAR TRANSMISSION				
						155 rpm	Max 2,1 km/h (1.3 mph)	A 28 cm (11 in)	75 cm (29.5 in)	45 (99)



PRINCESS MR

PRINCESS

M1 - MR



PRINCESS M1

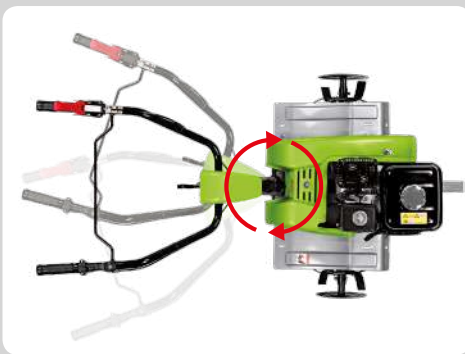

PRINCESS MR

		HP-kW	CC	 L (US qts)						 kg (lb)
M1	3000 Kohler	HP 5.5 - kW 4.1	196/1	3,6 (3.8)		① 132 rpm	--	A 32 cm (12 in)	30-52-77 cm (12-20-30 in)	62 (137)
	GX 160 Honda	HP 4.8 - kW 3.6	163/1	3,1 (3.3)						59 (130)
MR	3000 Kohler	HP 5.5 - kW 4.1	196/1	3,6 (3.8)		① 132 rpm	Max 2,3 km/h (1.4 mph)	A 32 cm (12 in)	30-52-77 cm (12-20-30 in)	64 (141)
	GX 160 Honda	HP 4.8 - kW 3.6	163/1	3,1 (3.3)						61 (134)



PRINCESS

MP3



		HP-kW	CC	 L (US qts)					 kg (lb)
MP3	3000 Kohler	HP 5.5 - kW 4.1	196/1	3,6 (3.8)		GEAR TRANSMISSION			65 (143)
	GX 160 Honda	HP 4.8 - kW 3.6	163/1	3,1 (3.3)		① 36 rpm ② 160 rpm	Max 2,3 km/h (1.4 mph)	A 32 cm (12 in)	30-52-77 cm (12-20-30 in)









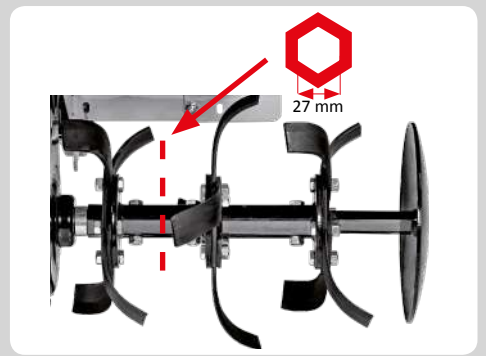



PRINCESS MP3 PRO

PRINCESS

MP3 PRO



										
	HP-kW	CC	L (US qts)		GEAR TRANSMISSION					kg (lb)
MP3 PRO	GX 200 Honda	HP 5.5 - kW 4.1	196/1	3,1 (3.3)		① 36 rpm ② 160 rpm	Max 2,3 km/h (1.4 mph)	A 33 cm (13 in)	56-82 cm (22-32 in)	66 (145)

2500 - 3500



2500











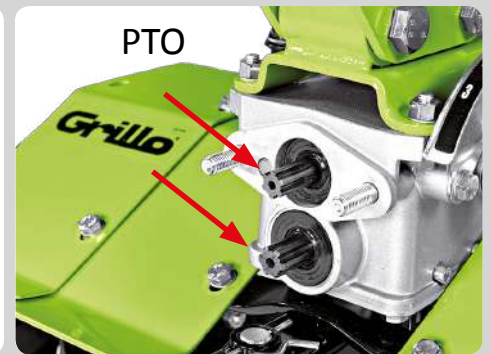
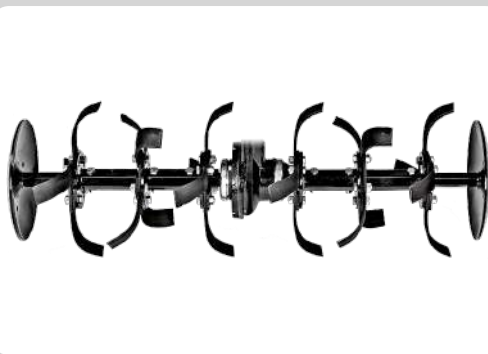







3500



		HP-kW	CC	 L (US qts)						 kg (lb)
2500	3000 Kohler	HP 5.5 - kW 4.1	196/1	3,6 (3.8)		GEAR TRANSMISSION ⓪ 53 rpm ⓑ 123 rpm		A 32 cm (12 in)	58-85 cm (23-33 in)	75 (165)
	EX 17	HP 5 - kW 3.7	169/1	3,6 (3.8)						74 (163)
	GX 160 Honda	HP 4.8 - kW 3.6	163/1	3,1 (3.3)						72 (159)
3500	3000 Kohler	HP 5.5 - kW 4.1	196/1	3,6 (3.8)		GEAR TRANSMISSION ⓪ 53 rpm ⓑ 123 rpm		A 32 cm (12 in)	58-85-111 cm (23-33-43 in)	81 (179)
	EX 17	HP 5 - kW 3.7	169/1	3,6 (3.8)						80 (176)
	GX 160 Honda	HP 4.8 - kW 3.6	163/1	3,1 (3.3)						78 (172)

11500



		HP-kW	CC 	 L (US qts)						 kg (lb)
11500	EX 27	HP 8.3 - kW 6.1	265/1	 6,1 (6.4)		GEAR TRANSMISSION				90 (198)
	350 Lombardini Kohler	HP 7.5 - kW 5.5	349/1	Diesel  4,3 (4.5)		① 53 rpm ② 123 rpm ③ 162 rpm	Max 3 km/h (1.8 mph)	A 33 cm (13 in)	59-86-112 cm (23-34-44 in)	110 (242)
	350 Lombardini Kohler	HP 7.5 - kW 5.5	349/1	Diesel  4,3 (4.5)						121 (267)

G 45

CONTRA-ROTATING TILLER









		HP-kW	CC	 L (US qts)		GEAR TRANSMISSION				 kg (lb)
G 45	GR 200 GRILLO	HP 5.5 - kW 4.1	196/1	3 (3.2)		 4.00-8 1,6 km/h (1 mph) →	 4.00-8 2,5 km/h (1.5 mph) ←	 A 26 cm (10 in)	 50 cm (20 in)	82 (181)

G 46





CONTRA-ROTATING TILLER



										
	HP-kW	CC	L (US qts)		GEAR TRANSMISSION				kg (lb)	
G 46	GX 200 Honda HP 5.5 - kW 4.1	196/1	3,1 (3.3)		 1,6 km/h (1 mph) →	 1,6 km/h (1 mph) ←	A 26 cm (10 in)	50 cm (20 in)	98 (216)	

G 52

















										
G 52	GR 200 GRILLO	HP 5.5 - kW 4.1	196/1	3 (3.2)		GEAR TRANSMISSION		A 26 cm (10 in)	37-50 cm (15-20 in)	67 (148)
						 13x5.00-6 1,4 km/h (0.9 mph) → 2,2 km/h (1.4 mph) ←	 13x5.00-6 2,2 km/h (1.4 mph) → 1,4 km/h (0.9 mph) ←			

G 55



LABOUR KIT











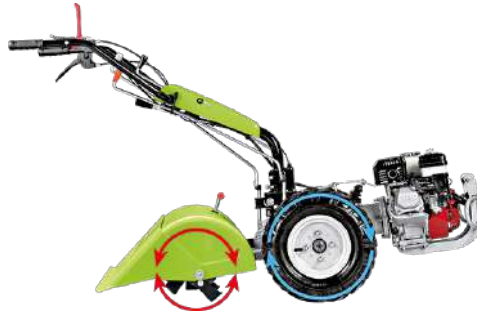



		HP-kW		 L (US qts)						 kg (lb)
G 55	3000 Kohler	HP 5.5 - kW 4.1	196/1	3,6 (3.8)		GEAR TRANSMISSION  4.00-8 1,1 km/h (0.7 mph)  2,6 km/h (1.6 mph)		A 26 cm (10 in)	37-50-58 cm (15-20-23 in)	86 (189)
	GX 160 Honda	HP 4.8 - kW 3.6	163/1	3,1 (3.3)		 4.00-8 1,1 km/h (0.7 mph)  2,6 km/h (1.6 mph)				86 (189)

G 84



FORWARD AND CONTRA-ROTATING TILLER



		HP-kW		 L (US qts)						 kg (lb)
G 84	GX 200 Honda	HP 5.5 - kW 4.1	196/1	3,1 (3.3)		GEAR TRANSMISSION  4.00-8 ① 1,1 km/h (0.7 mph) ② 2,6 km/h (1.6 mph) → ① 1,1 km/h (0.7 mph) ② 2,6 km/h (1.6 mph) ←	 4.00-8 ① 1,1 km/h (0.7 mph) ② 2,6 km/h (1.6 mph) → ① 1,1 km/h (0.7 mph) ② 2,6 km/h (1.6 mph) ←	A 32 cm (12 in)	37-47-58 cm (15-19-23 in)	105 (230)

G 85d



FORWARD AND CONTRA-ROTATING TILLER



		HP-kW	CC	 L (US qts)		 DIFF. LOCK				 kg (lb)
G 85d	EX 27	HP 8.3 - kW 6.1	265/1	 6,1 (6.4)		✓	 4.00-8	 4.00-8		113 (249)
	350 Kohler Lombardini	HP 7.5 - kW 5.5	349/1	 4,3 (4.5)		✓	⓪ 1,1 km/h (0.7 mph) Ⓜ 2,6 km/h (1.6 mph)	⓪ 1,1 km/h (0.7 mph) Ⓜ 2,6 km/h (1.6 mph)		127 (280)
	EX 27	HP 8.3 - kW 6.1	265/1	 6,1 (6.4)		✓				125 (275)
	350 Kohler Lombardini	HP 7.5 - kW 5.5	349/1	 4,3 (4.5)		✓	⓪ 1,1 km/h (0.7 mph) Ⓜ 2,6 km/h (1.6 mph)	⓪ 1,1 km/h (0.7 mph) Ⓜ 2,6 km/h (1.6 mph)	A 32 cm (12 in)	144 (317)

37-47-58-68-77 cm
(15-19-23-27-30 in)

G 107d



		HP-kW	CC	 L (US qts)		 DIFF. LOCK					 kg (lb)
G 107d	EX 27	HP 8.3 - kW 6.1	265/1	 6,1 (6.4)		✓	GEAR TRANSMISSION 4.00-10 ① 1,2 km/h (0.7 mph) ② 2,2 km/h (1.4 mph) ③ 3,3 km/h (2.1 mph) →	 4.00-10 ① 1,2 km/h (0.7 mph) ② 2,2 km/h (1.4 mph) ③ 3,3 km/h (2.1 mph) →			122 (269)
	440 Kohler Lombardini	HP 11 - kW 8.1	441/1	 Diesel 5 (5.3)		✓	 4.00-10 ① 1,2 km/h (0.7 mph) ② 2,2 km/h (1.4 mph) ③ 3,3 km/h (2.1 mph) →	 4.00-10 ① 1,2 km/h (0.7 mph) ② 2,2 km/h (1.4 mph) ③ 3,3 km/h (2.1 mph) →			148 (326)
	EX 27	HP 8.3 - kW 6.1	265/1	 6,1 (6.4)		✓	 4.00-10 ① 1,2 km/h (0.7 mph) ② 2,2 km/h (1.4 mph) ③ 3,3 km/h (2.1 mph) →	 4.00-10 ① 1,2 km/h (0.7 mph) ② 2,2 km/h (1.4 mph) ③ 3,3 km/h (2.1 mph) →			137 (302)
	440 Kohler Lombardini	HP 11 - kW 8.1	441/1	 Diesel 5 (5.3)		✓	 4.00-10 ① 1,2 km/h (0.7 mph) ② 2,2 km/h (1.4 mph) ③ 3,3 km/h (2.1 mph) →	 4.00-10 ① 1,2 km/h (0.7 mph) ② 2,2 km/h (1.4 mph) ③ 3,3 km/h (2.1 mph) →	A 32 cm (12 in)	37-47-58-68-77 cm (15-19-23-27-30 in)	162 (357)

G 108 - G 110









































G 108























G 110



		 CC/HP HP-kW	  L (US qts)		 Steering Brakes	 DIFF. LOCK						 kg (lb)
G 108	GX 270 Honda	270 cc/1 HP 8.4 - kW 6.3	 5,3 (5.6)		✓	✓	 1,3 km/h (0.8 mph)	 2,4 km/h (1.5 mph)	 4,3 km/h (2.7 mph)			132 (291)
G 110	GX 390 Honda	389 cc/1 HP 11.7 - kW 8.7	 6,1 (6.4)		✓	✓	 0.7 km/h (0.4 mph)	 1.5 km/h (0.9 mph)	 3.2 km/h (2.0 mph)			A 32 cm (12.6 in)
	440 Kohler Lombardini	441 cc/1 HP 11 - kW 8.1	 Diesel 5 (5.3)		✓	✓	 1,3 km/h (0.8 mph)	 2,4 km/h (1.5 mph)	 4,3 km/h (2.7 mph)			
												164 (361)











G 131



		HP-kW	CC 	 L (US qts)		 DIFF. LOCK					 kg (lb)
G 131	3 LD 510 Lombardini	HP 12.2 - kW 9	510/1	Diesel 5,3 (5.6)		✓	GEAR TRANSMISSION  5.00-12  1,2 km/h (0.7 mph)  2,4 km/h (1.5 mph)  3,4 km/h (2.1 mph)  7.1 km/h (4.4 mph)  1.7 km/h (1.0 mph)  3.5 km/h (2.2 mph)	 5.00-12  1.7 km/h (1.0 mph)  3.5 km/h (2.2 mph)	A 32 cm (12.6 in)	55-70-85 cm (22-28-34 in)	215 (474)

X TRIMMER



										
	HP-KW	CC	L (US qts)							kg (lb)
X TRIMMER	575 EX B&S HP 3-KW 2.2	140/1	0,8 (0.84)		--	25 cm (9.8 in)	45 - 57 mm (1.8 - 2.2 in)	45 cm (17.7 in)	30 (66)	

HWT 550 Tilt

HWT 600 WD



HWT 600 WD



HWT 600 WD

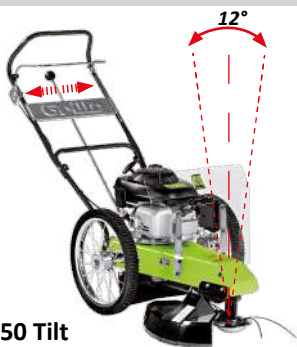



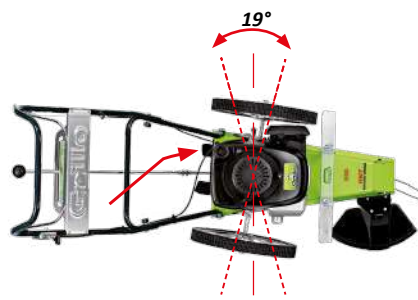







HWT 550 Tilt



HWT 550 Tilt













										
HWT 550 Tilt	GCV 160 Honda	HP 4.4 - kW 3.3	160/1	0,9 (1)		--	41 cm (16.2 in)	10-25-45-57 mm (0.4-1-1.8-2.2 in)	60 cm (24 in)	40 (88)
HWT 600 WD	GCV 160 Honda	HP 4.4 - kW 3.3	160/1	0,9 (1)		GEAR TRANSMISSION 3 km/h (1.9 mph)	41 cm (16.2 in)	10-25-45-57 mm (0.4-1-1.8-2.2 in)	60 cm (24 in)	44 (97)

HWT 700

SUPERTRAC



										
HWT 700 SUPERTRAC	<i>Kawasaki</i> FJ180V KAI	HP 4.5 - kW 3.3	179/1	1.7 (1.5)		GEAR TRANSMISSION 2 km/h (1.2 mph)	3.50-8 38 cm (14.9 in)	15-30-50-60 mm (0.6-1.2-2-2.4 in)	60 cm (24 in)	55 (121)



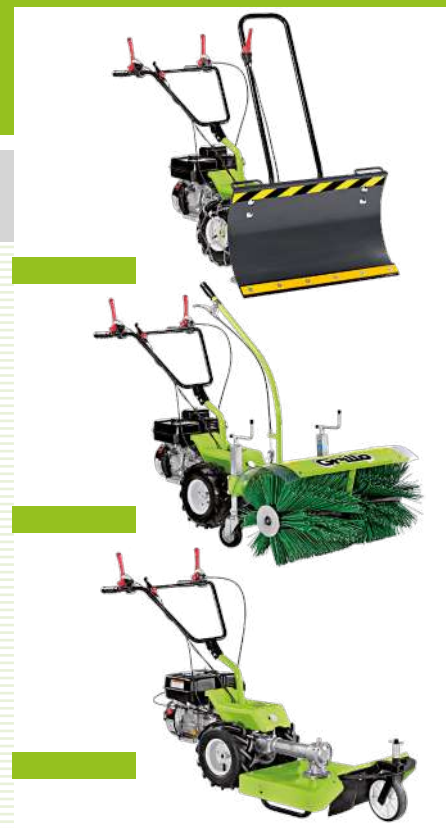















GF 1



		HP-kW	CC	 L (US qts)						 kg (lb)
GF 1	3000 Kohler	HP 5.5 - kW 4.1	196/1	3,6 (3.8)		13x5.00-6	GEAR TRANSMISSION 2,20 km/h (1.4 mph)	--	86-96 cm (34-38 in)	67 (148)
	EX 17	HP 5 - kW 3.7	169/1	3,6 (3.8)		13x5.00-6	2,20 km/h (1.4 mph)	--	86-96 cm (34-38 in)	66 (146)

GF 2



























		HP-kW	 CC/1	 L (US qts)						 kg (lb)
GF 2	3000 Kohler	HP 5.5 - kW 4.1	196/1	3,6 (3.8)			GEAR TRANSMISSION		110-115-117 cm (43-45-46 in)	95 (209)
	GX 160 Honda	HP 4.8 - kW 3.6	163/1	3,1 (3.3)			 4.00-8  1,0 km/h (0.6 mph)  2,0 km/h (1.2 mph)  3,0 km/h (1.9 mph)	 4.00-8  1,0 km/h (0.6 mph)  2,0 km/h (1.2 mph)  3,0 km/h (1.9 mph)		95 (209)

GF 3 - GF 3DF



GF 3DF



		HP-kW	CC	 L (US qts)		 Steering Brakes	 DIFF. LOCK				 kg (lb)
GF 3	EX 27	HP 8.3 - kW 6.1	265/1	 6,1 (6.4)		-	-	GEAR TRANSMISSION			115 (254)
	350 Kohler Lombardini	HP 7.5 - kW 5.5	349/1	 Diesel 4,3 (4.5)		-	-	 5.00-10	 5.00-10		
GF 3DF	EX 27	HP 8.3 - kW 6.1	265/1	 6,1 (6.4)		✓	✓	 I 1,3 km/h (0.8 mph)	 I 1,3 km/h (0.8 mph)	110-115-117 127-135 cm (43-45-46-50-53 in)	127 (280)
	350 Kohler Lombardini	HP 7.5 - kW 5.5	349/1	 Diesel 4,3 (4.5)		✓	✓	 II 2,4 km/h (1.5 mph)	 II 2,4 km/h (1.5 mph)		122 (269)
								 III 3,6 km/h (2.2 mph)	 III 3,6 km/h (2.2 mph)		134 (295)

















DUMPER 406



									
Dumper 406	3000 Kohler	HP 5.5 - kW 4.1	196/1			GEAR TRANSMISSION			241 (531)
	GX 200 Honda	HP 5.5 - kW 4.1	196/1			① 1,0 km/h (0.6 mph) ② 2,0 km/h (1.2 mph) ③ 3,5 km/h (2.2 mph)	① 1,0 km/h (0.6 mph) ② 2,0 km/h (1.2 mph) ③ 3,5 km/h (2.2 mph)	400 kg (882 lb)	242 (533)

DUMPER 507













										
Dumper 507	EX 27	HP 8.3 - kW 6.1	265/1	 6,1 (6.4)		GEAR TRANSMISSION		500 kg (1102 lb)	276 (608)	
	EX 27	HP 8.3 - kW 6.1	265/1	 6,1 (6.4)		<ul style="list-style-type: none"> Ⓘ 1,0 km/h (0.6 mph) Ⓙ 2,0 km/h (1.2 mph) Ⓚ 3,5 km/h (2.2 mph) Ⓛ 8,7 km/h (5.4 mph) 	<ul style="list-style-type: none"> Ⓘ 1,0 km/h (0.6 mph) Ⓙ 2,0 km/h (1.2 mph) Ⓚ 3,5 km/h (2.2 mph) 		288 (635)	
	350 Kohler Lombardini	HP 7.5 - kW 5.5	349/1	 Diesel 4,3 (4.5)						286 (631)
	350 Kohler Lombardini	HP 7.5 - kW 5.5	349/1	 Diesel 4,3 (4.5)						311 (686)

GH 7 - GH 9









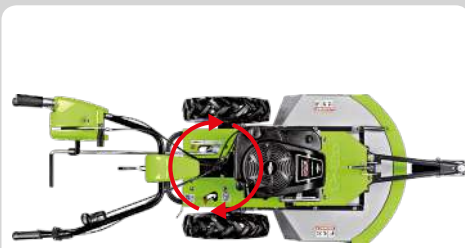



GH 9

		HP-kW		 L (US qts)						 kg (lb)
GH 7	GX 200 Honda	HP 5.5 - kW 4.1	196/1	3,1 (3.3)		HYDROSTATIC 0 - 6 km/h (0 - 3.7 mph) 0 - 3 km/h (0 - 1.9 mph)		30...110 mm (1.2...4.3 in)	68 cm (26.8 in)	148 (326)
GH 9	GX 270 Honda	HP 8.4 - kW 6.3	270/1	5,3 (5.6)		HYDROSTATIC 0 - 6 km/h (0 - 3.7 mph) 0 - 3 km/h (0 - 1.9 mph)		30...110 mm (1.2...4.3 in)	68 cm (26.8 in) 85 cm (33.5 in)	158 (348) 165 (364)











CL 62



										
CL 62	INTEK 950E Series B&S	HP 5.6 - kW 4.2	223/1	1,1 (1.2)		HYDROSTATIC		50...110 mm (2.0...4.3 in)	62 cm (24.4 in)	99 (218)
						0 - 6 km/h (0 - 3.7 mph)	0 - 3,5 km/h (0 - 2.2 mph)			









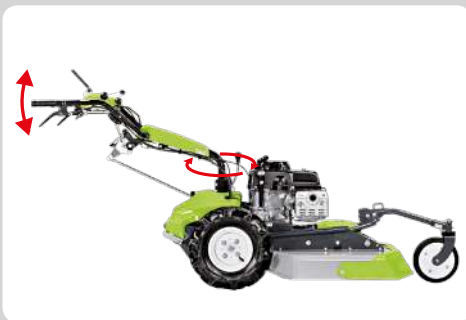

CL 62M



										
		HP-kW	CC	L (US qts)		HYDROSTATIC				kg (lb)
CL 62M	KAWASAKI FJ180V	HP 4.5 - kW 3.4	179/1	1,6 (1.5)		0 - 4,7 km/h (0 - 2.9 mph)	0 - 3 km/h (0 - 1.9 mph)	50...110 mm (2.0...4.3 in)	62 cm (24.4 in)	98 (216)

CL 75



		HP-kW		 L (US qts)									
CL 75	GXV 390 Honda	HP 10.2 - kW 7.6	389/1	2,1 (2.2)		✓	HYDROSTATIC		0 - 6 km/h (0 - 3.7 mph)	0 - 3,5 km/h (0 - 2.2 mph)	50...150 mm (2.0...5.9 in)	75 cm (29.5 in)	140 (309)

CLIMBER 7

7.15 - 7.18















CLIMBER 7.18



CLIMBER 7.18



		HP-kW		 L (US qts)	 DIFF. LOCK	 HYDROSTATIC				 kg (lb)
7.15	GR 452 GRILLO	HP 12(*15) kW 9.2	452/1	 7 (7.4)		0 - 9 km/h (0 - 5.6 mph)	45 cm (18 in)	35...85 mm (1.3...3.3 in)	85 cm (33.5 in)	250 (551)
7.18	INTEK 7180 B&S	HP 15.2 - kW 11.2	656/2	 7 (7.4)		0 - 9 km/h (0 - 5.6 mph)	45 cm (18 in)	35...85 mm (1.3...3.3 in)	85 cm (33.5 in)	255 (562)











CLIMBER 8

8.22



KIT MULCHING











		HP-kW		 L (US qts)						
8.22	7220 Prof. Series B&S	HP18-kW13.2	656/2	 7 (7.4)	 ✓	HYDROSTATIC 0 - 10 km/h (0 - 6.2 mph)	60 cm (23.6 in)	35...110 mm (1.3...4.3 in)	91 cm (36 in)	290 (639)

CLIMBER 10

2WD 27













		HP-kW		 L (US qts)	 DIFF. LOCK	 HYDROSTATIC				 kg (lb)
2WD 27	FS 730V KAWASAKI	HP 22-kW 16.2	726/2	13 (13.7)	✓	0 - 9,5 km/h (0 - 5.9 mph)	65 cm (25.6 in)	35...135 mm (1.4...5.3 in)	98 cm (38,5 in)	375 (827)

CLIMBER 10

AWD 22



		HP-kW		 L (US qts)	 DIFF. LOCK	 HYDROSTATIC				 kg (lb)
AWD 22	7220 Prof. Series B&S	HP18-kW13.2	656/2	 13 (13.7)		0 - 9 km/h (0 - 5.6 mph)	70 cm (27.5 in)	35...135 mm (1.4...5.3 in)	93 cm (36.6 in)	345 (761)

CLIMBER 10









AWD 27



AWD 27



AWD 27

		HP-kW		 L (US qts)	 DIFF. LOCK	 HYDROSTATIC				
AWD 27	8270 Commercial Series B&S	HP 22 - kW 16.2	724/2	13 (13.7)	✓	0 - 9 km/h (0 - 5.6 mph)	70 cm (27.5 in)	35...135 mm (1.4...5.3 in)	98 cm (38.6 in)	385 (849)

MD 15-MD 18



MD 18



MD 18



MD 15









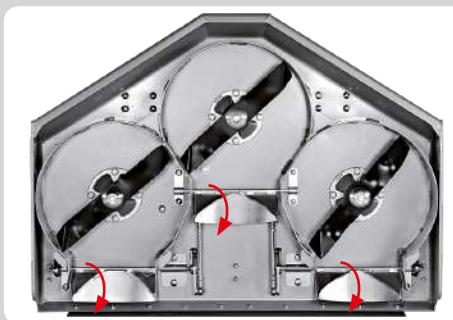

MD 18

		HP-kW		 L (US qts)	 DIFF. LOCK	 HYDROSTATIC	 45 cm (18 in)	 25...75 mm (1.0...3.3 in)	 83 cm (32.6 in)	 kg (lb)
MD 15	GR 452 GRILLO	HP 12(*15) kW 9.2	452/1	 7 (7.4)	—	0 - 9 km/h (0 - 5.6 mph)	45 cm (18 in)	25...75 mm (1.0...3.3 in)	83 cm (32.6 in)	225 (496)
MD 18	INTEK 7180 B&S	HP 15.2 - kW 11.2	656/2	 7 (7.4)	✓	0 - 9 km/h (0 - 5.6 mph)	45 cm (18 in)	25...80 mm (1.0...3.5 in)	83 cm (32.6 in)	238 (525)

MD 22N



		HP-kW		 L (US qts)						
					DIFF. LOCK	HYDROSTATIC			QUICK SHIFT	
MD 22N	7220 Prof. Series B&S	HP 18- kW13.2	656/2	7 (7.4)	✓	0 - 10,5 km/h (0 - 6,5 mph)	48 cm (18.9 in)	25...110 mm (0.9...4.3 in)	110 cm (43 in)	315 (694)

MD 24 AWD

MD 28 AWD



MD 28 AWD

















MD 24 AWD



MD 28 AWD













										
		HP-KW	CC	L (US qts)	DIFF. LOCK	HYDROSTATIC			QUICK SHIFT	kg (lb)
MD 24 AWD	7220 Prof. Series B&S	HP18 - kW13.2	656/2			0-9 km/h (0 - 5,6 mph)	70 cm (27.5 in)	25...110 mm (0.9...4.3 in)	110 cm (43 in)	370 (816)
MD 28 AWD	8270 Commercial Series B&S	HP22 - kW16.2	724/2			0-9 km/h (0 - 5,6 mph)	70 cm (27.5 in)	25...110 mm (0.9...4.3 in)	130 cm (51 in)	383 (844)

FX 27











Zero-Turn



										
FX 27	8270 Commercial Series B&S	HP22-kW 16.2	724/2	 30 (7.9) L (US Gal)	0 - 12 km/h (0 - 7.4 mph) HYDROSTATIC	ZERO TURN	30...85 mm (1.2...3.3 in) ELECTRIC	125 cm (49 in)	484 (1067)	H 170 cm D 132 cm W 258 cm

FD 220R















		HP-kW		 L (US qts)						
FD 220R	GR 452 GRILLO	HP 12(*15) kW 9.2	452/1	 7 (7.4)	HYDROSTATIC 0 - 9 km/h (0 - 5.6 mph)	200 L 5.7 (US bu)	30 cm (11.8 in)	30...90 mm (1.2...3.5 in)	80 cm (31 in)	263 (580)
	VANGUARD 16 B&S	HP 14 - kW 10.3	479/2	 7 (7.4)	HYDROSTATIC 0 - 9 km/h (0 - 5.6 mph)	200 L 5.7 (US bu)	30 cm (11.8 in)	30...90 mm (1.2...3.5 in)	80 cm (31 in)	270 (595)

H 114 cm
D 86 cm
W 234 cm















FD 280



		HP-kW		 L (US qts)								
FD 280	VANGUARD 16 B&S	HP 14 - kW10.3	479/2			HYDROSTATIC 0-9,5 km/h (0-5.9 mph)	ELECTRIC 280 L 8 (US bu)	30 cm (11.8 in)	30...90 mm (1.2...3.5 in)	113 cm (44 in)	320 (705)	H 120 cm D 119 cm W 238 cm

FD 450



												
	HP-kW	CC	L (US Gal)	DIFF. LOCK	HYDROSTATIC	HYDRAULIC	HYDRAULIC	ELECTRIC		kg (lb)	H D W	
FD 450	7220 Prof. Series B&S	HP 18 - kW 13.2	656/2			0 - 11 km/h (0 - 6.8 mph)	450 L 12.8 (US bu)	30 cm (11.8 in)	25...90 mm (1.0...3.5 in)	113 cm (44 in)	450 (992)	H 194 cm D 119 cm W 268 cm

FD 900

4WD



		HP-kW	CC	 L (US Gal)	 DIFF. LOCK	 HYDROSTATIC	 HYDRAULIC	 HYDRAULIC	 HYDRAULIC	 HYDRAULIC	 kg (lb)	 H D W
FD 900 4WD	3TNV80F YANMAR	HP 25 - kW 18.4	1267/3	Diesel 31 (8.2)	✓	0 - 15 km/h (0 - 9 mph)	750 L 21.3 (US bu)	37 cm (14.6 in)	20...100 mm (0.8...3.9 in)	126 cm (49.6 in)	980 (2160)	H 166 cm D 133 cm W 291 cm

FD 13.09

4WD



		HP-kW	CC	L (US Gal)	DIFF. LOCK	HYDROSTATIC	HYDRAULIC	HYDRAULIC	HYDRAULIC	HYDRAULIC	kg (lb)		
FD 13.09 4WD	3TNV82A YANMAR	HP 26 - kW 18.9	1331/3	Diesel 23 (6.0)	✓	0 - 15 km/h (0 - 9.3 mph)	900 L 25.5 (US bu)	31 cm (12 in)	HYDRAULIC	20...100 mm (0.8...3.9 in)	132 cm (52 in)	1230 (2712)	H 175 cm D 141 cm W 325 cm
									HYDRAULIC	20...120 mm (0.8...4.7 in)	155 cm (61 in)	1310 (2888)	H 175 cm D 162 cm W 340 cm

FD 2200

4WD



		HP-kW		 L (US Gal)								
					DIFF. LOCK	HYDROSTATIC	HYDRAULIC	HYDRAULIC			kg (lb)	H D W
FD 2200 4WD	3TNV88C YANMAR	HP 37 kW 27.5	1642/3	Diesel 50 (13.2)	✓	0 - 20 km/h (0 - 12.4 mph)	1200 L 34 (US bu)	62 cm (24 in)	25...110 mm (0.9...4.3 in)	155 cm (61 in)	1468 (3236)	H 183 cm D 162 cm W 347 cm

FD 2200 TS

4WD



		HP-kW		L (US Gal)	DIFF. LOCK	HYDROSTATIC	HYDRAULIC	HYDRAULIC	HYDRAULIC	HYDRAULIC	kg (lb)	
FD 2200 TOP SCORER 4WD	4TNV88C YANMAR	HP 47 kW 34.3	2190/4	Diesel 50 (13.2)	✓	0 - 21 km/h (0 - 13.6 mph)	1400 L 39.7 (US bu)	60 cm (24 in)	20...120 mm (0.8...4.7 in)	155 cm (61 in)	1656 (3651)	H 199 cm D 162 cm W 364 cm
									180 cm (71 in)	1705 (3758)		H 199 cm D 188 cm W 369 cm

FM 13.09

4WD



		HP-kW		 L (US Gal)	 DIFF. LOCK	 HYDROSTATIC	 HYDRAULIC			 kg (lb)		
FM 13.09 4WD	3TNV82A YANMAR	HP26 - kW18.9	1331/3	Diesel 23 (6.0)	✓	0 - 15 km/h (0 - 9.3 mph)	12000 m ² /h	31 cm (12 in)	20...100 mm (0.8...3.9 in)	160 cm (63 in)	1150 (2535)	H 175 cm D 192 cm W 325 cm

FM 2200

4WD



		HP-kW	CC	L (US Gal)	DIFF. LOCK	HYDROSTATIC		HYDRAULIC			kg (lb)	
FM 2200 4WD	3TNV88C YANMAR	HP 37 kW 27.5	1642/3	Diesel 50 (13.2)	✓	0 - 20 km/h (0 - 12.4 mph)	15500 m ² /h	62 cm (24 in)	20...90 mm (0.8...3.5 in)	160 cm (63 in)	1322 (2914)	H 185 cm D 192 cm W 342 cm



GZ 1 - GZ 2 - GZ 3

PRINCESS M1 - MR

PRINCESS MP3

PRINCESS MP3 PRO

2500 - 3500

11500

G 45

G 46

G 52

G 55

G 84

G 85d

G 107d

G 108 - G 110

G 131

X TRIMMER

HWT 550 TILT

HWT 600 WD

HWT 700 SUPERTRAC

GF 1

GF 2

GF 3 - GF 3DF

Dumper 406

Dumper 507

GH 7 - GH 9

CL 62-CL 62M

CL 75

Climber 7

Climber 8

Climber 10 2WD

Climber 10 AWD

MD 15

MD 18

MD 22N

MD 24 AWD - MD 28 AWD

FX 27

FD 220R

FD 280

FD 450

FD 900

FD 13.09 4WD

FD 2200 4WD

FD 2200 TS 4WD

FM 13.09 4WD

FM 2200 4WD

Nell'ottica di un costante sviluppo dei propri prodotti, Grillo Spa si riserva il diritto di cambiare le specifiche tecniche e le illustrazioni su questo documento in qualsiasi momento e senza preavviso ne obbligo. Foto e caratteristiche non contrattuali. In his pursuing of constant development of his products, Grillo Spa reserves for himself the right to change the technical specifications and the illustrations on this document, at any given moment and without notice and without any kind of obligation. All the pictures characteristics are not contract-binding. En poursuivant une politique constante d'amélioration de ses produits, Grillo Spa se réserve le droit de modifier les spécifications techniques en tout temps sans préavis ni obligation. Photographies et caractéristiques non contractuelles. Aufgrund ständiger Weiterentwicklung behält sich Grillo Spa Änderungen in Form, Technik und Ausstattung der Produktpalette vor. Aus Angaben und Abbildungen des vorliegenden Grillo-Katalogs können daher keine Ansprüche abgeleitet werden. En vista de un desarrollo constante de sus productos, Grillo Spa se reserva el derecho de cambiar las especificaciones técnicas y las ilustraciones mostradas en este documento en cualquier momento y sin aviso previo. Las fotos y características no son contractuales.



www.grillospa.it
 e-mail: grillo@grillospa.it
 Tel. (0039) 0547.633111
 Fax (0039) 0547.632011

www.grillofrance.fr
www.grilloagrigarden.co.uk
www.grillodeutschland.de
www.grilloagrigarden.ru